



[www.aquariusengineers.biz](http://www.aquariusengineers.biz) 

Trusted since 1997

# AQUARIUS



## We Are Aquarius:

Aquarius Engineers is a leading Indian construction equipment company established in 1997.

We take pride in designing and delivering Stationary Concrete Pumps, Truck Mounted Boom Pumps, Concrete Batching Plants and accessories, that meet international quality standards, to Indian and international customers. Our wide range of products are designed using state-of-the-art technologies relevant to the needs of the markets we cater to.

Driven by a clear vision to be the most trusted knowledge and equipment source in the field of concrete production, conveying and placement, Aquarius has grown every year for more than 2 decades. With the same zest and commitment, we pledge to keep improving our products & services to our existing and new customers.

All our machines are designed, produced and validated at our state-of-the-art technology centers at Pune and Goa



Pune Plant



Goa Plant

## Works:

### Plant I

190, 191 Kundaim Industrial Estate, Kundaim, Goa – 403 115

### Plant II

S. No. 480, 481, 482 Ambadwet, Tal. Mulshi, Dist. Pune – 412 111

### WAREHOUSE

S. No. 480, 481, 482 Ambadwet, Tal. Mulshi, Dist. Pune – 412 111



## About us :

We have State-of-art manufacturing plants at Pune and Goa spread out over 14,000 sq.m. and 40,000 sq.m. of land respectively, focused on manufacturing advanced technology, robust construction equipment, that meet stringent national & international quality standards. Aquarius operates on an all India canvas with regional sales & service offices spread across the country. Aquarius is proud to offer an excellent round-the clock after-sales service and spare part support to our domestic and international customers. Knowledge and safety is a focus area at Aquarius and we offer monthly operator training programs to ensure maximum benefit to customer by ensuring operator and best machine performance at site.

### The Management System is Certified by

ISO 9001: 2015

Quality Management System

ISO 14001: 2015

Environment Management System

ISO 45001: 2018

Occupational Health and Safety  
Management System

The Management System at Pune Factory and Corporate Office is also certified by ISO 9001: 2015

AQUARIUS products also have the following certifications:



CE Certification



SONCAP Certification



AUTHORIZED ECONOMICS OPERATOR-TI CERTIFICATE

Certificate of Recognition ONE STAR EXPORT HOUSE

## Products:

- **STATIONARY CONCRETE PUMPS**
- HIGH PERFORMING SERIES
- HIGH PRESSURE SERIES
- ELECTRIC SERIES (VIDYUT)
- **MOBILE LINE PUMPS**
- **TRUCK MOUNTED BOOM PUMPS**
- **BATCHING PLANTS**
- COMPACT BATCHING PLANTS
- COMPARTMENT BIN PLANTS
- SUPER MOBILE BATCHING PLANTS
- INLINE BIN PLANTS (SKIP SERIES, CONVEYOR BELT SERIES)
- **STATIONARY BOOM PLACERS**
- **CONCRETE WASH**





## Our Mission:

To bring state-of-the-art technology products, services and expertise to the industry we serve, with a focus on delivering complete and reliable solutions to our customers, with the intention of adding value to their businesses and becoming their long-term partners.



## Our Vision:

To be the most trusted knowledge and equipment source in the field of concrete production, conveying and placement in India. To continually invest in better technology, set-ups and engineering, to adopt, upgrade and deliver better solutions to our customers.

## Our Values:

**Integrity:** We will be among the most trusted companies in our area of business. We will be honest, transparent and ethical in our conduct.

**Passion for Excellence:** Our products and services will aim at harnessing the latest relevant technologies and the highest standards of quality in our area of business, with due consideration to our safety and environmental responsibilities. We will value and promote meritocracy.



**Reliability:** We will focus on delivering complete and reliable solutions to our customers, with the intention of adding value to their businesses and becoming their long-term partners.

**Customer Focus:** Our customers are the reason for our success. We commit to listen and respond positively to their needs.

**Adaptability:** We are open to change and welcome new ideas from our employees, customers and others. We will explore new ways to continually grow our business through teamwork and collaboration.



AATMA-NIRBHAR  
**BHARAT**

वसुधैव कुटुम्बकम्

ONE EARTH • ONE FAMILY • ONE FUTURE

# THINK CONCRETE THINK AQUARIUS

# STATIONARY BOOM PLACERS

SB 33, SB 36

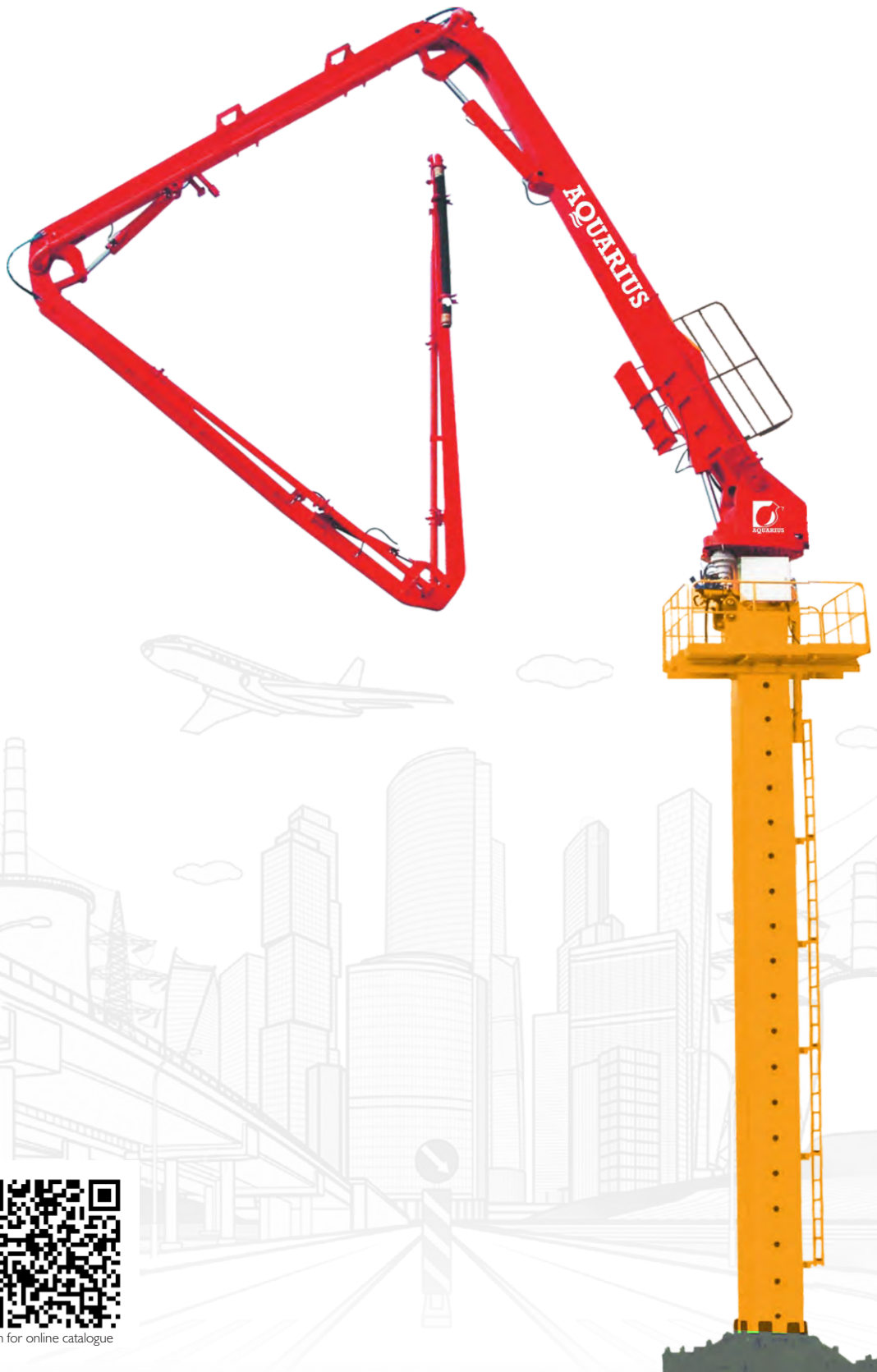

Stationary Placing Booms



Scan for online catalogue

## FEATURES

- Modular weight optimized design for easy installation via tower crane
- Radio remote as standard supply
- Easy installation in floors as well as in lift shafts
- Meets ASME B30.27-2014 Standard

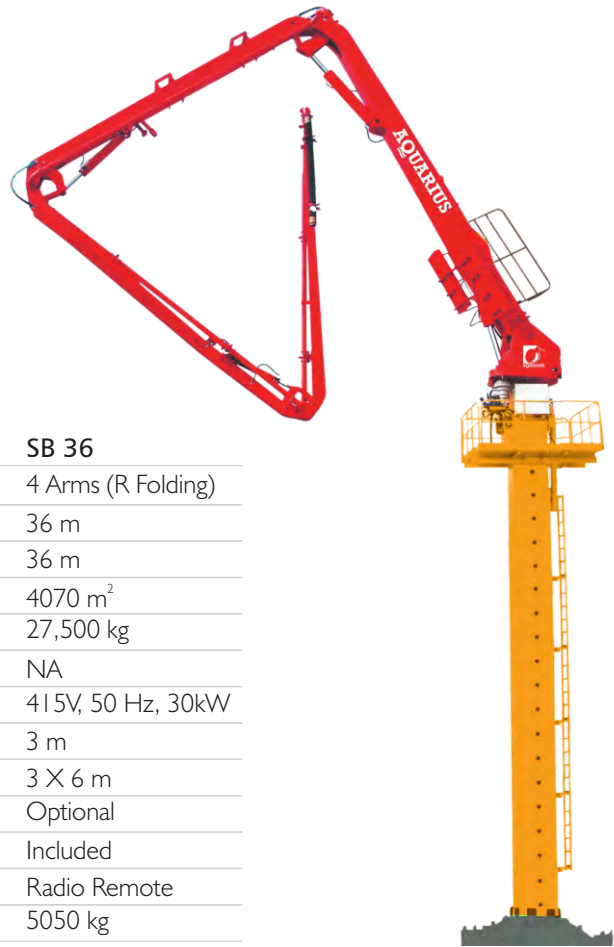

## DATA SHEET

Model Specifications	SB 33	SB 36
Arms	3 Arms (R Folding)	4 Arms (R Folding)
Horizontal Reach	33 m	36 m
Vertical Reach	33 m	36 m
Working Range	3420 m <sup>2</sup>	4070 m <sup>2</sup>
Machine Weight (Total)	21,000 kg	27,500 kg
Counter Weight	NA	NA
Electrical Power	415V, 50 Hz, 15kW	415V, 50 Hz, 30kW
End Hose Length	3 m	3 m
Mast Set	3 X 6 m	3 X 6 m
Cross Base and anchor set	Optional	Optional
Mast Hydraulic Climbing System	Included	Included
Remote Control	Radio Remote	Radio Remote
Weight of Heaviest Part	3100 kg	5050 kg

## TECHNICAL DRAWING

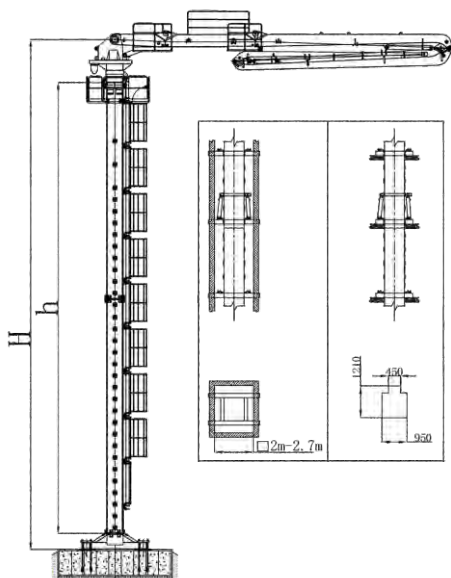

SB 33

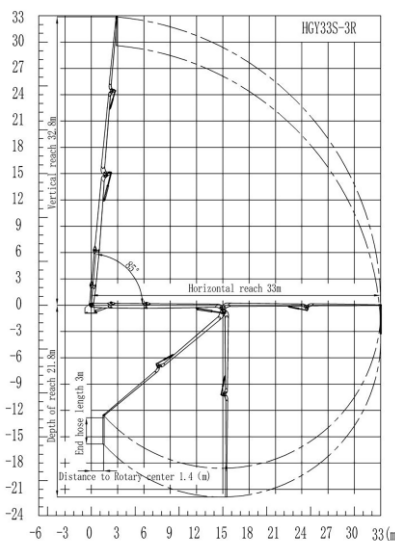

SB 36

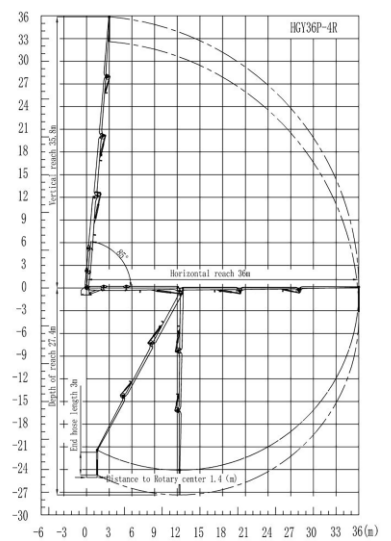

# PRODUCT RANGE WITH MODELS

## HIGH PERFORMING STATIONARY CONCRETE PUMPS

703 D, 704 D, 1004 D SHP, 1405 D, 1407 D



## HIGH PRESSURE STATIONARY CONCRETE PUMPS

1400 HPD, 1400 HPD+, 1407 D HR, 1407 D HR+



## VIDYUT CONCRETE PUMPS

1003 E, 1405 E, 1406 E, 1400 HPE, 1400 HRE



## MOBILE LINE PUMPS

1004 D SHP MOLI, 1405 D MOLI, 1407 D MOLI, 1407 D HR MOLI



## TRUCK MOUNTED BOOM PUMPS

M 20 Z, 37 ZX, 40 ZX



## STATIONARY BOOM PLACERS

SB 33, SB 36

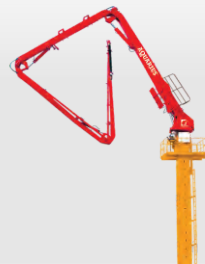

## COMPACT BATCHING PLANTS

Z 30



## COMPACT BATCHING PLANTS

X1, X1.25, X2, X2.5, X3



## SUPER MOBILE BATCHING PLANTS

T 21 & T 30



## COMPARTMENT BIN PLANTS

MP 30, MP 40, MP 60, MP 70



## INLINE BIN PLANTS

SKIP SERIES  
SP 30, SP 40, SP 60, SP 70



## INLINE BIN PLANTS

CONVEYOR BELT SERIES  
SP 60 C, SP 70 C, SP 90 C, SP 120 C



## CONCRETE WASH

CW 10



Scan for Product video

## OUR NETWORK

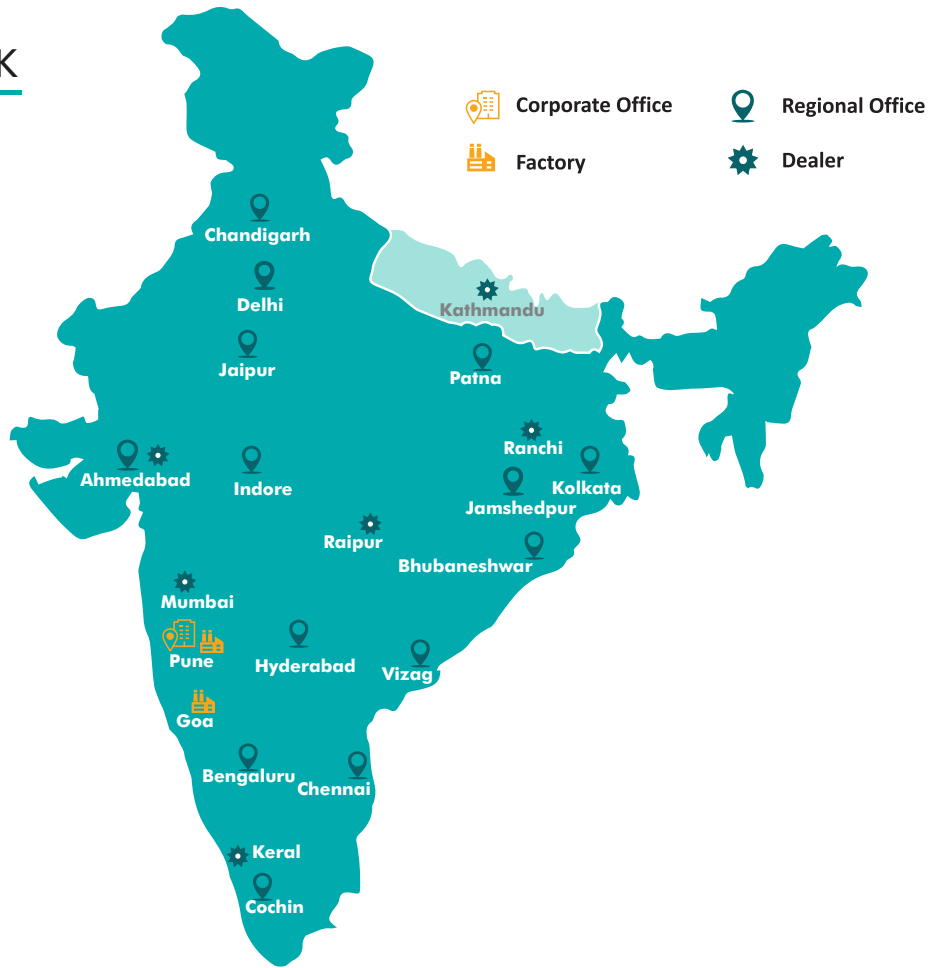

## REGIONAL CONTACT DETAILS

### Ahmedabad

U-8, B Wing, Samudra Complex, Sardar Patel Colony, Off C. G. Road, Near Girish Cold Drink, Navrangpura, Ahmedabad 380 006

M: + 91 8411020218

### Bhubaneswar

Plot No. D-8, Maitri Vihar, Bhubaneswar 751 016

Tel.: +91 6742301330

M: +91 9372211002

### Bengaluru

No. 1/A, Manjunatha Colony, Third Floor, 24th Main, 5th A Cross, J.P. Nagar, 2nd Phase, Bengaluru 560 078

M: +91 9611655330

### Delhi

Prop No. 27, Ground Floor, Block – 7, Kirti Nagar Industrial Area, New Delhi 110 015

Tel.: +91 11 43306438

M: +91 9873333147

### Hyderabad

S.Y. No. 400, Plot No. 31 & 32, IDA Kukatpally, Ayanna's Industrial Park, Prashanth Nagar, Hyderabad 500 037 (TG)

Tel.: +91 40 43905241

M: +91 9966629800

### Indore

G-1, Surya Apartment, 193, Anoop Nagar, A. B. Road, Indore 452 008 (MP)

Tel.: +91 731 3074078

M: +91 8411020218

### Chandigarh / Punjab

SCO-68, Choura Bazaar-2, Chandigarh Ambala Highway, Zirakpur 140 603 (Punjab)

Tel.: +91 7710777186

M: +91 7710777182

### Kolkata

U-1/137, Baishnabghata Patuli Township, P. O. Panchasayar, P. S. Patuli, Kolkata 700 094

Tel.: +91 33 40612128

M: +91 9163999596

### Mumbai

W414, T.T.C. Industrial Area, MIDC Industrial Area, Rabale, Navi Mumbai 400 701 Maharashtra

M: +91 8411020218

### Jaipur

Plot No KC-5, NIZI Khatadari, Narayan Vihar-K, Village Asarpura, Sanganer, Jaipur 302 020

M: +91 9828217557

### Visakhapatnam

Plot No. M-1/I, B- Block, Autonagar, Visakhapatnam – 530012 Andhra Pradesh

M: +91 8977757992 / +91 9000144063

### Chennai

M: +91 9175935704

### Jamshedpur

M: +91 9372211002

### Raipur

M: +91 8411020218

### Cochin

M: +91 9175935704

### Pune

M: +91 9371641414

M: +91 9326565636

### Patna

M: +91 9163999596

### Export

M: +91 8390900388

### Goa

M: +91 9326565636



## AQUARIUS GENUINE SPARE PARTS

At Aquarius, we strive to excel at and continuously improve our after-sales services and spare parts support. Aquarius is renowned for high-quality spare parts and highly responsive after-sales service. Fast turnaround time is our strength. We have an ERP-backed India-wide spare parts warehouse network, special spares stock for the Indian subcontinent market and an established spares support framework for other international customers.



**19+**  
SPARE PARTS  
OUTLETS

Spares Support:  
☎ +91 97300 23236

**125+**  
SERVICE  
ENGINEERS

Service Support:  
☎ +91 77989 86650

## OUR INTERNATIONAL FOOTPRINT



**8000+** MACHINE POPULATION\*

- |               |            |            |               |             |
|---------------|------------|------------|---------------|-------------|
| 📍 USA         | 📍 Canada   | 📍 Iraq     | 📍 Oman        | 📍 Sri Lanka |
| 📍 Algeria     | 📍 Colombia | 📍 Kenya    | 📍 Philippines | 📍 Somalia   |
| 📍 Bangladesh  | 📍 DR Congo | 📍 Maldives | 📍 Puerto Rico | 📍 Tanzania  |
| 📍 Bhutan      | 📍 Gambia   | 📍 Myanmar  | 📍 Russia      | 📍 Togo      |
| 📍 Burundi     | 📍 Ghana    | 📍 Nepal    | 📍 Rwanda      | 📍 UAE       |
| 📍 Benin       | 📍 Israel   | 📍 Nigeria  | 📍 Senegal     | 📍 Uganda    |
| 📍 South Sudan | 📍 Zanzibar | 📍 Zambia   |               |             |

\*Including sales in India



## **AQUARIUS ENGINEERS PVT. LTD.**

**Concrete Pumps, Batching Plants, Boom Pumps**

**An ISO 9001: 2015 Certified Company**

'Aquarius House', Sheelavihar Colony, Off Karve Road, Pune 411 038. INDIA  
Tel.: +91 20 2544 5227 / 28 Email: [enquiries@aquariusengineers.biz](mailto:enquiries@aquariusengineers.biz)  
Web: [www.aquariusengineers.biz](http://www.aquariusengineers.biz)



Follow us on     /aquariusengineers